

Measuring Hard Processes at STAR

Brian Lasiuk

Yale University

Department Of Physics

- Heavy Ion Physics
 - Before RHIC
 - ...at RHIC (What RHIC gives us...)
- Capabilities of STAR
- High P_T Observables
- Importance

The Nuclear/QCD Potential

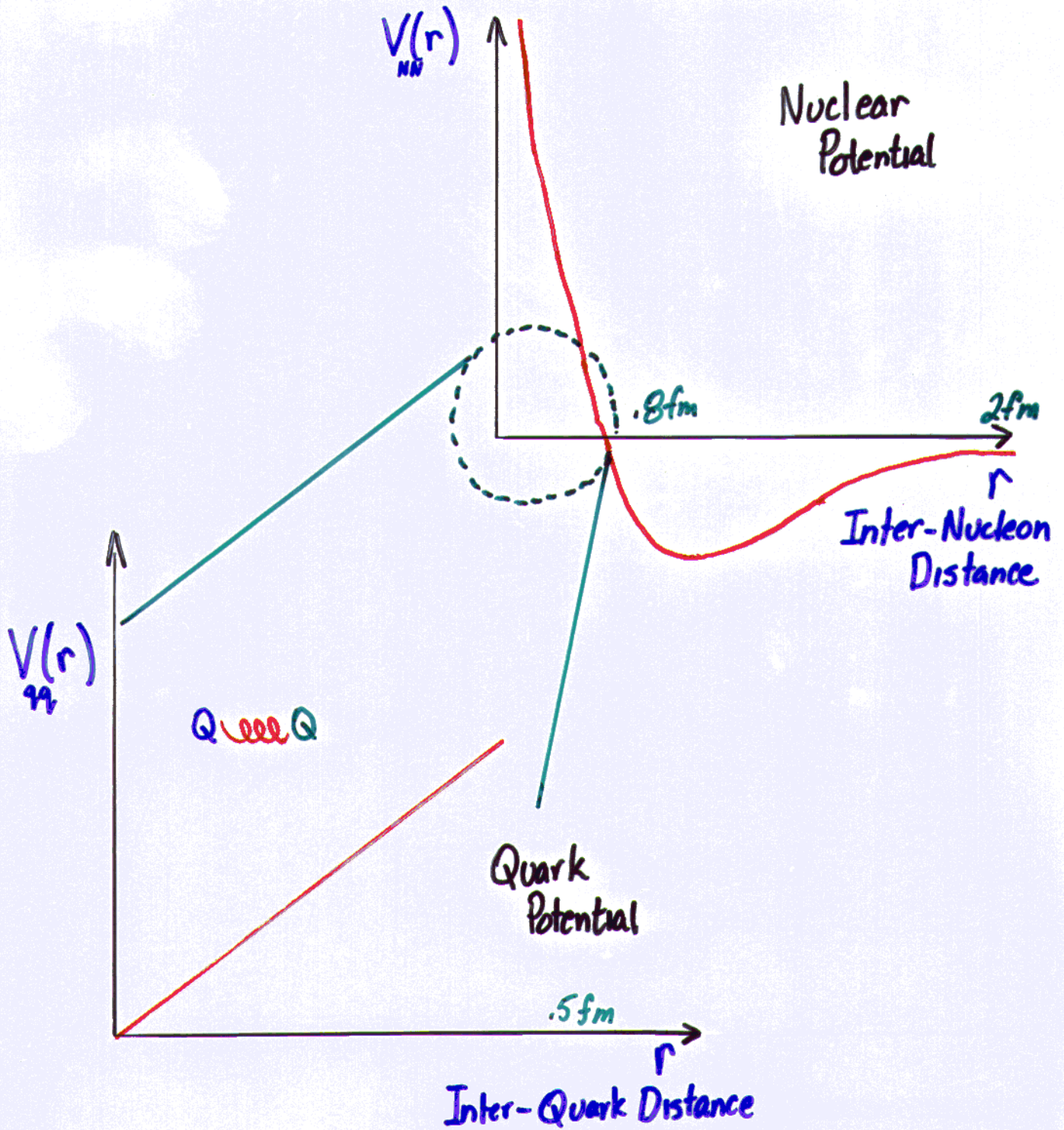

Hadronic Evolution

⇒ Heavy Ion Collisions encompass all aspects of hadronic processes

- Free (Asymptotic Limit) [Note: Initial State]
- Short Range Effects and Parton Production
- Parton Equilibrium (pQCD → phenom.)
- *Universal Phenomenon* Hadronization (fragmentation function)
- Hadronic Interactions (in medium)
↑ effective theory!!

Transitional Region is Most Difficult to Describe

- laminar → turbulent flow
- static → dynamic
- ...

...Non-Equilibrium Physics

Soft Physics

Hadronization is universal $\Rightarrow e^+e^-$, pp, AA

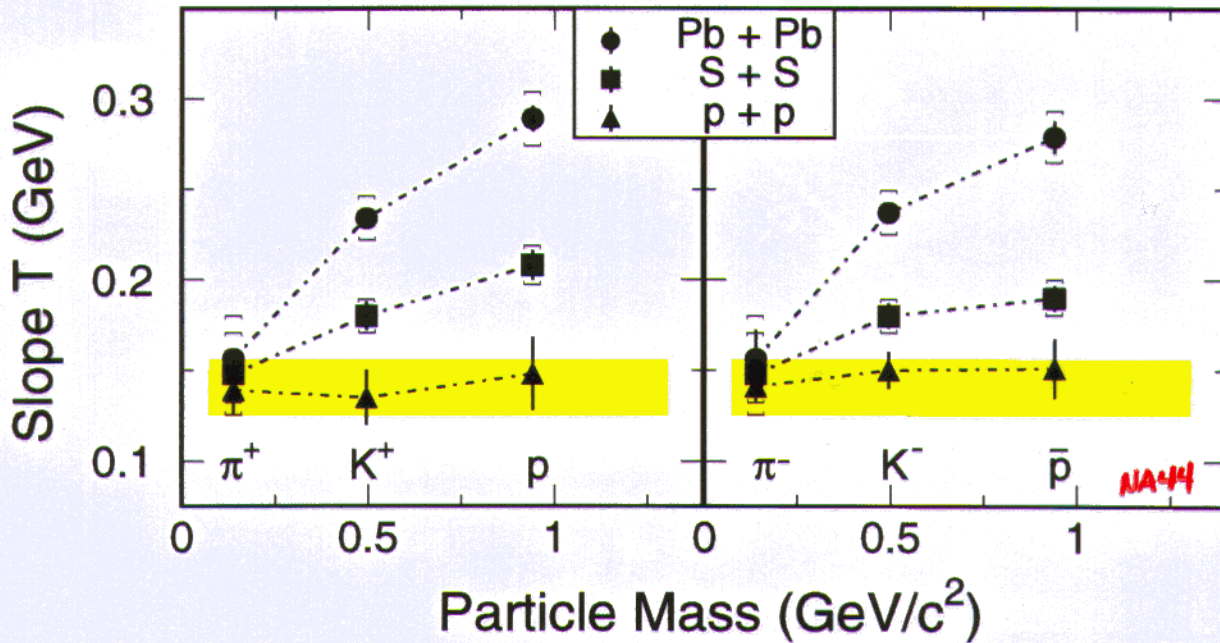

CONDITIONS & ENVIRONMENT SHAPE THE FINAL STATE
IN DIFFERENT WAYS. EVEN AT CERN-SPS
ENERGIES, PARTICLE SPECTRA ARE DECIDEDLY
SOFT IN NATURE

... STILL DESCRIBED IN PHENOMENOLOGY
IT WORKS... WELL... BUT...

Partition Function

$$Z \sim \int d\psi d\bar{\psi} e^{\int d^4x \mathcal{L}}$$

$$\mathcal{E} = \frac{T^2}{V} \frac{\partial \ln Z}{\partial T}$$

$$S \sim \frac{1}{V} \left. \frac{\partial T \ln Z}{\partial T} \right|_{V_n}$$

We have access only to statistical properties
assuming EQUILIBRIUM !!!!

At RHIC we have hope to map calculations
from 1st principles to extended

HADRONIC SYSTEMS

Make use of well tested & trusted weak coupling
METHODS!!!

Energy Evolution

• CERN-SPS $\sqrt{s} \sim 17$ GeV

HARD PROCESSES

Fluctuations

• RHIC $\sqrt{s} \sim 200$ GeV



$\sim 50\%$ of energy transfer

• Tevatron $\sqrt{s} \sim 2000$ GeV

Dominant

AT RHIC, ESTIMATES SUGGEST $\sim 50\%$ OF ENERGY IS TRANSFERRED VIA PROCESSES

QUANTIFIABLE WITH WEAK COUPLING TECHNIQUES

• Not as easy as "simple" system \Rightarrow MUCH SOFT EXISTS!

Processes of Interest

How TO SEE PARTONS AND EFFECTS AT RHIC?

- **Jets and Mini-Jets** → SMOKING GUN EXPERIMENTS
RATES CALCULATED AND EXPERIMENTALLY TESTED IN e^+e^- COLLISIONS ...
 - qq interaction
 - asymptotically free

- **Quarkonia** → NOT RESCATTERING
 - Heavy System
 - Radiative Corrections Small
 - gg fusion

How does this relate to study of matter and search for collective (transitional behavior) effects?

STAR

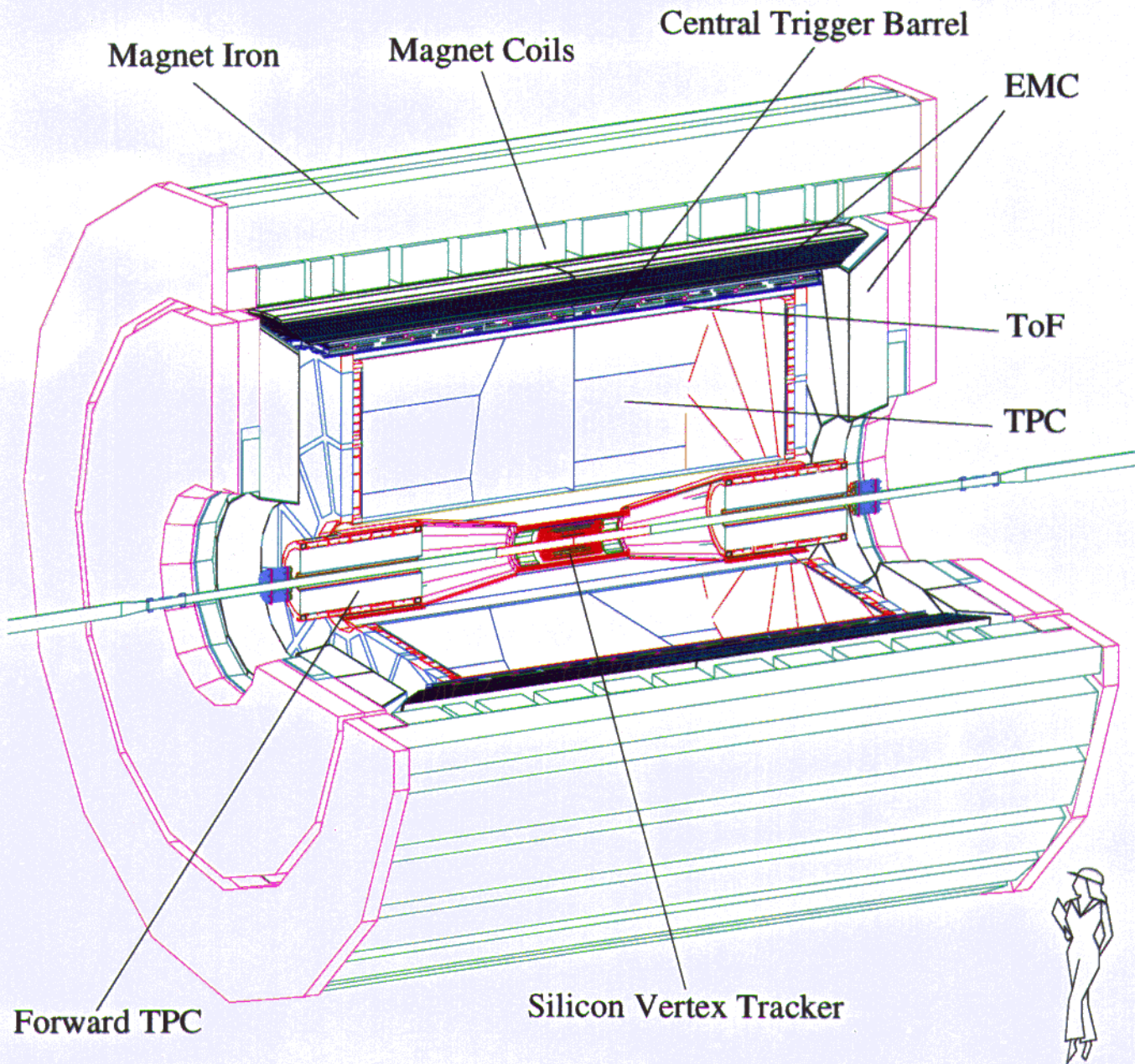

RICH - PID

Hijing Au+Au 200 AGeV Central

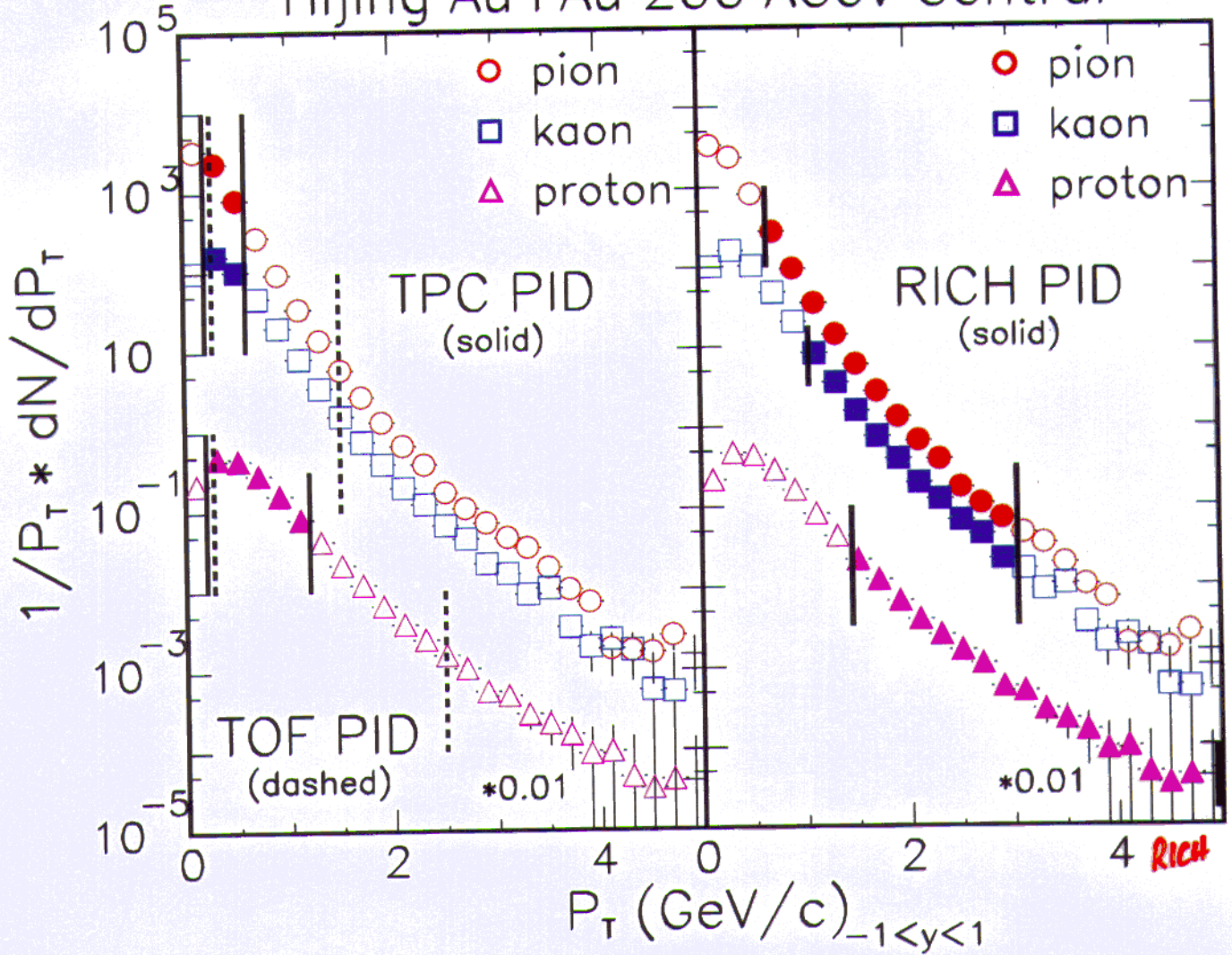

π/K separation $1 < p < 3$ (GeV/c)

p ID $1.5 < p < 5$ (GeV/c)

Effects of Hard Processes

The Picture that started it all...

**CAN WE UNDERSTAND INTERACTION OF A PARTON
IN MEDIA?.....**

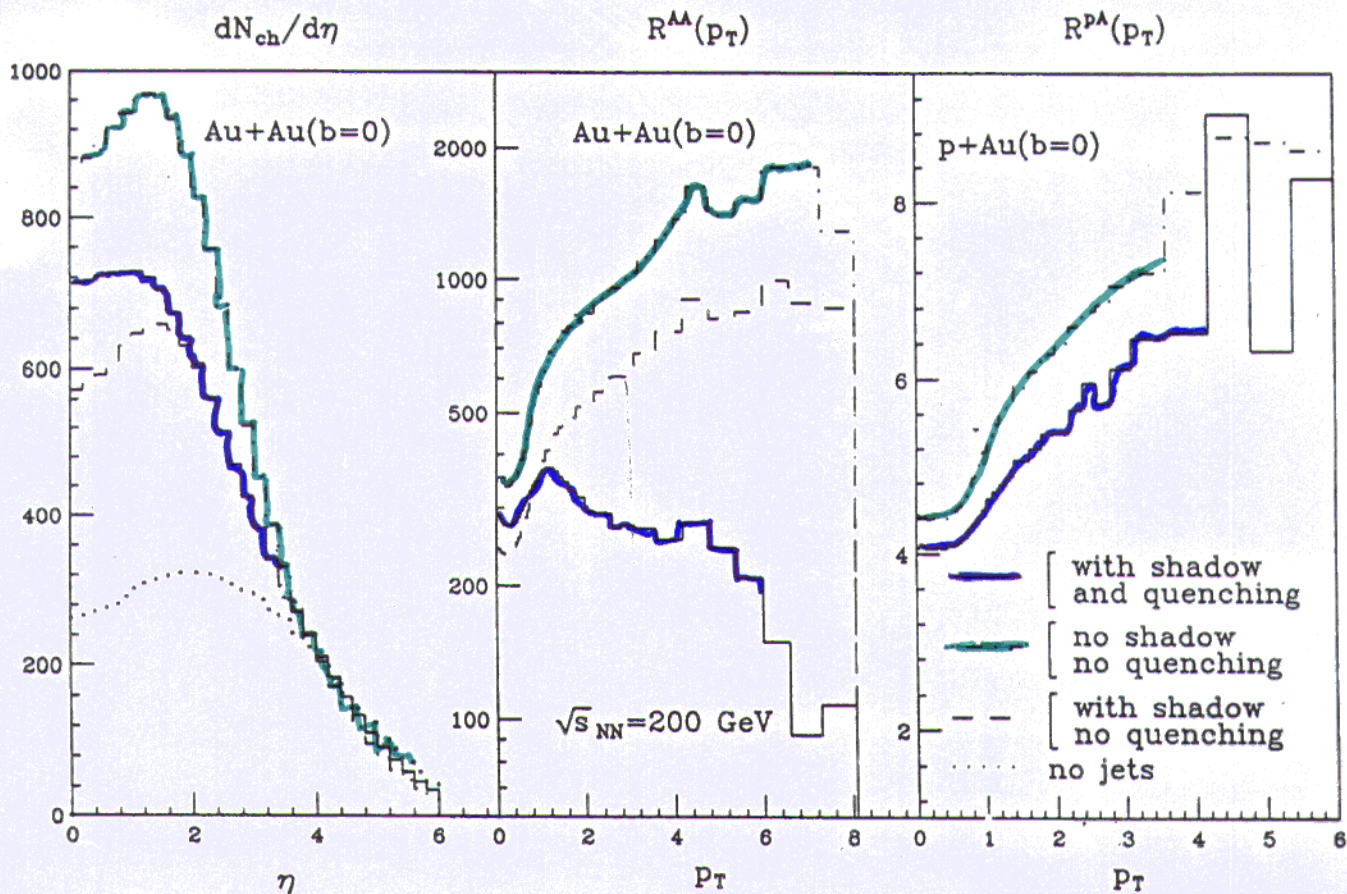

XN Wang
M Gyulassy
PRL 68 (1992) 1480

Jet Quenching (Energy Loss)

THE SPECTRUM SOFTENS...

- Medium Effects
- QGP → Debye screening
- Hadronic Gas → weak interaction

$$R \sim \frac{dN/dp_T |_{AuAu}}{dN/dp_T |_{pp}}$$

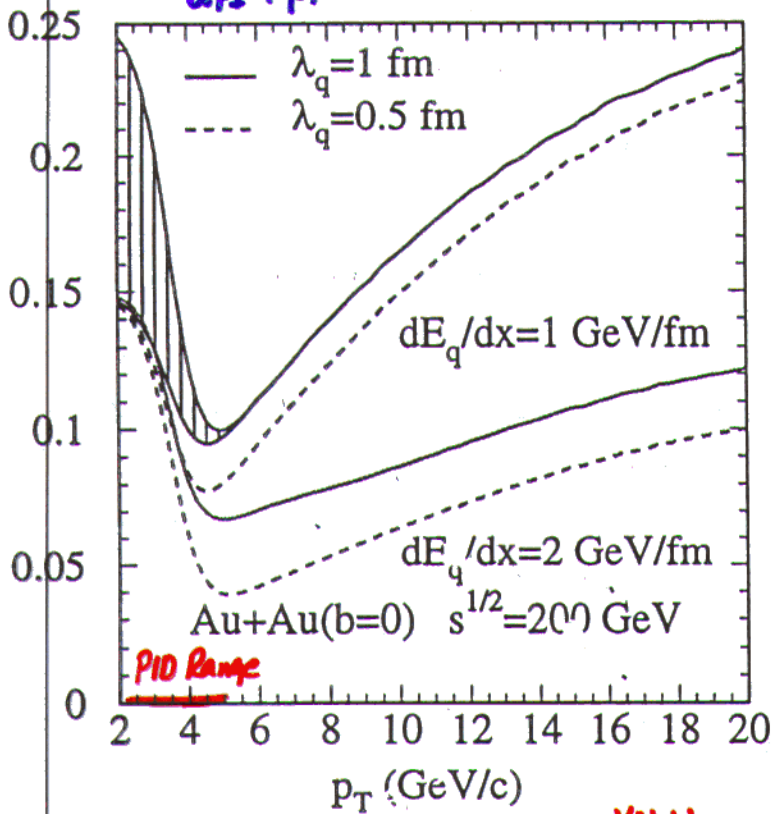

XN Wang

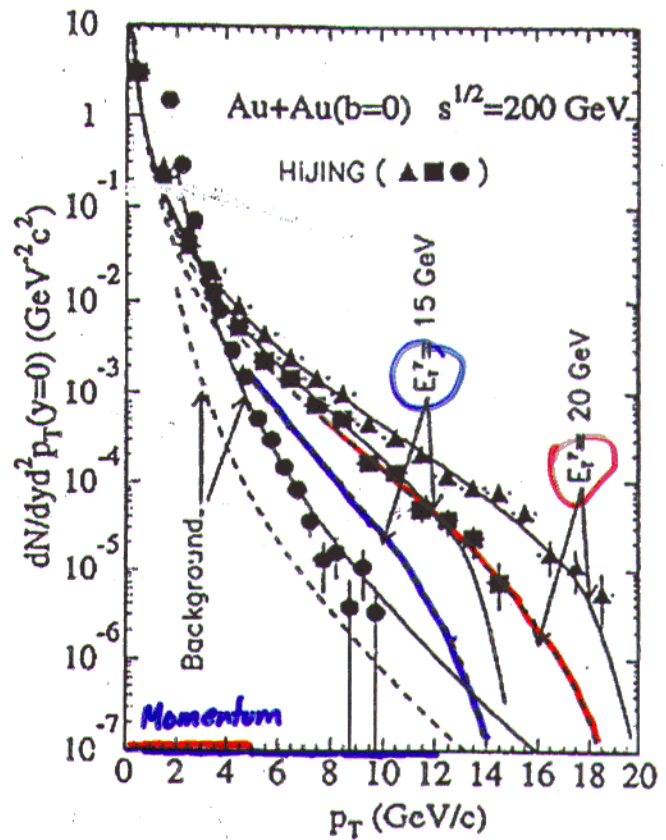

XN Wang.

PL BRINGS IN HADRONIZATION EFFECTS...

Jet Finding

STAR is actively studying jet finding algorithms

ϵ ... Discrimination Between γ , jets
(Shower Profile)

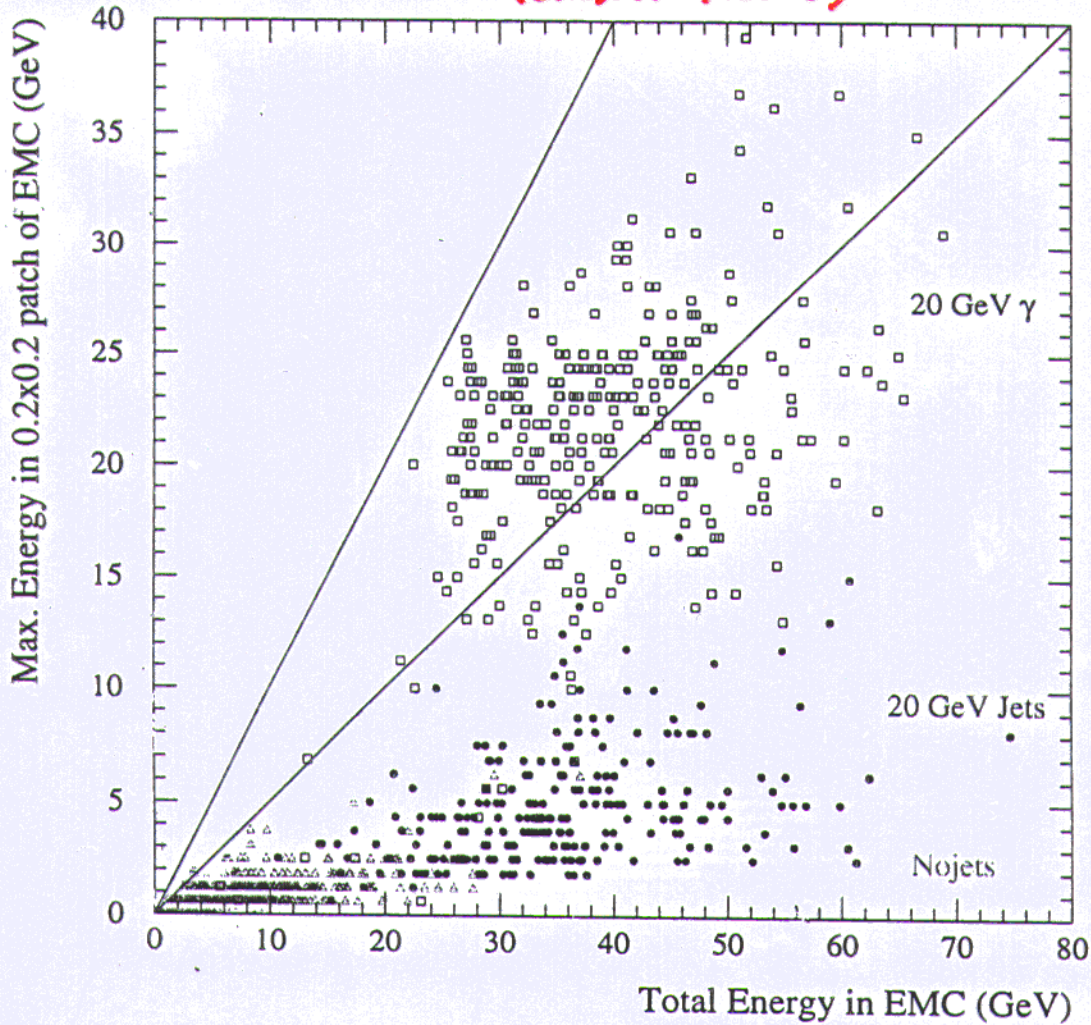

G. Nestfall et al. - SN.

γ -Jet Events

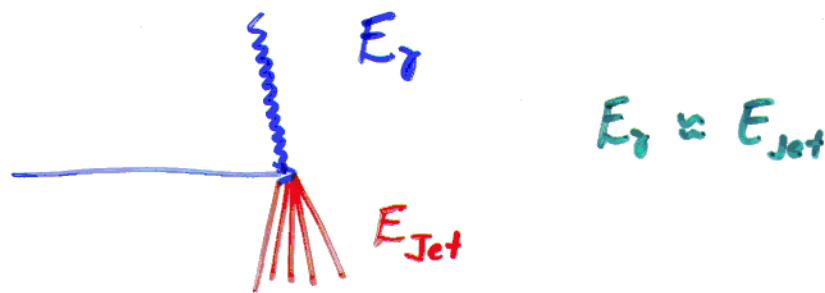

The Jet is a remnant of a high energy parton

It interacted with the matter... (γ weakly couples)

1. DOES ENERGY BALANCE HOLD?
 2. DOES PLANARITY HOLD?
 3. IS THERE A DIFFERENCE IN FLAVOR COMPOSITION OF THE JET?
- } Interaction of Parton

- What does this tell us???
- Can we experimentally do this?

Jet-Correlations

Oops... Initial k_T DEPENDENCE.

AT NLO $E_{JET} \neq E_j \Rightarrow$ model arguments
 $dE/d\Delta \sim \Delta k$

γ - γ Events??

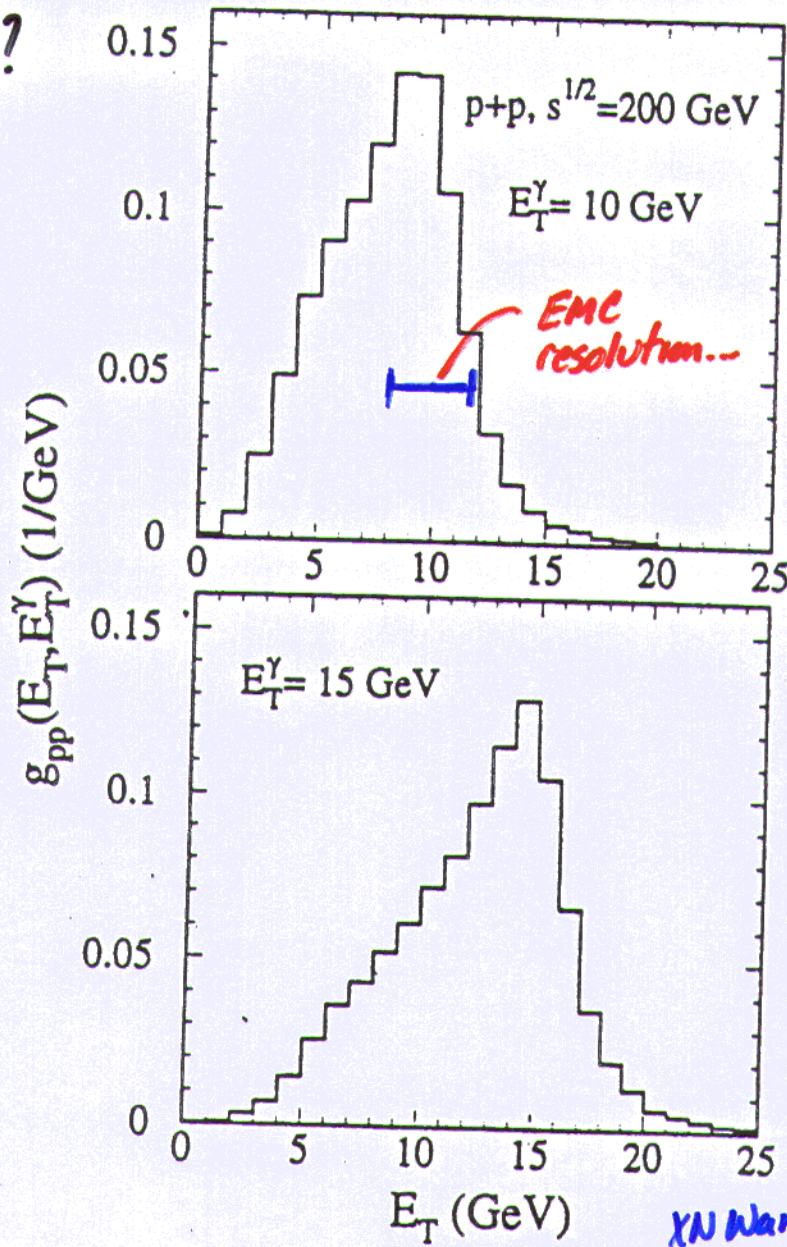

Rate Estimate

At STAR in pp:

$$\mathcal{L} \sim 10^{31} \text{ cm}^{-2}/\text{s}$$

6000-7000 γ -jet events/year $E_0 > 10 \text{ GeV}$

For AuAu

X-section scales by:

- at least $A \sim 200$
- more so $A^{4/3} \sim 1200$

but

$$\mathcal{L}_{\text{AuAu}} \sim 10^{26} \text{ cm}^{-2}/\text{s}$$

$$\frac{[6000 \text{ -- } 7000]}{10^5} \times [200 \text{ -- } 1200]$$

$\sim 10 \text{ -- } 1000$ per year....

D_1 -photons are even rarer....

Why so difficult?

Flavor Tagging

We can see a difference in fragmentation

HADRONIZATION IN: VACUUM \leftrightarrow MATTER

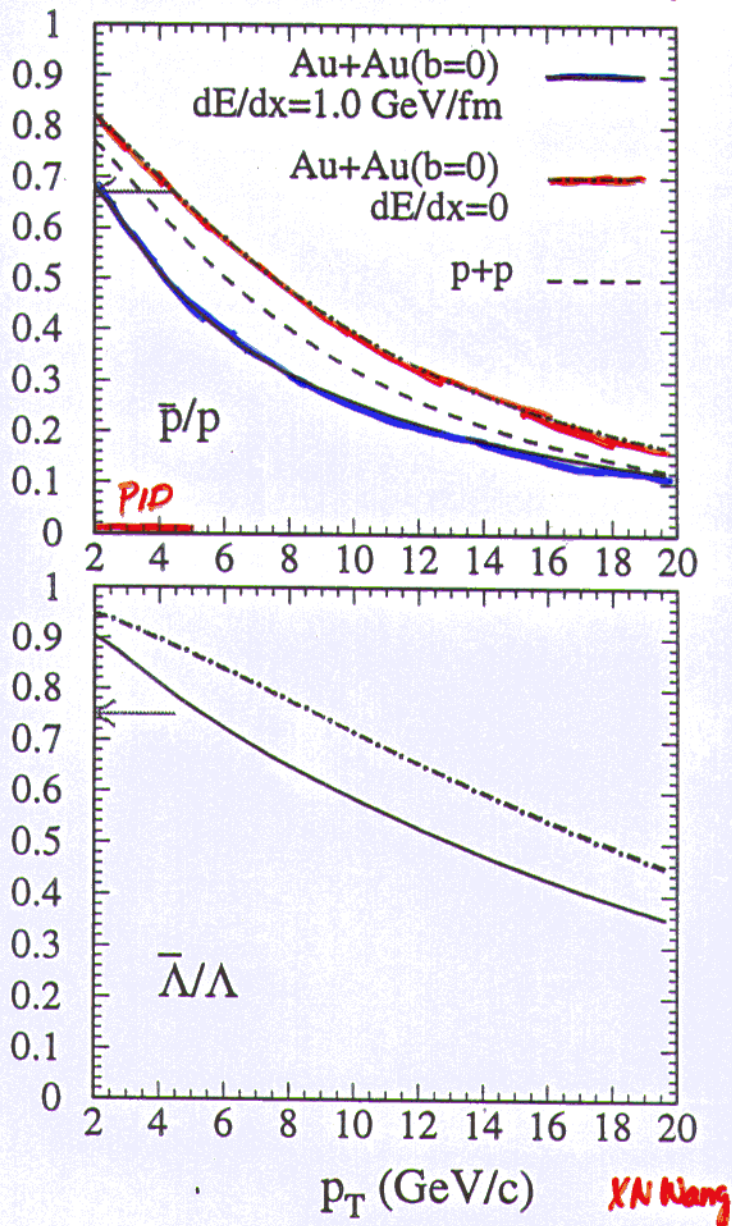

Quarkonia

- Production Rates are Calculable via pQCD

$t\bar{t}$ $b\bar{b}$ $c\bar{c}$

Gluon Fusion Processes

- Extremely Sensitive to type of environment
- Decay EM
 $J/\psi \rightarrow e^+e^-$
- Small X-section
- STAR Rate ...
- but acceptance large and e/h rejection ???

TPC – PID

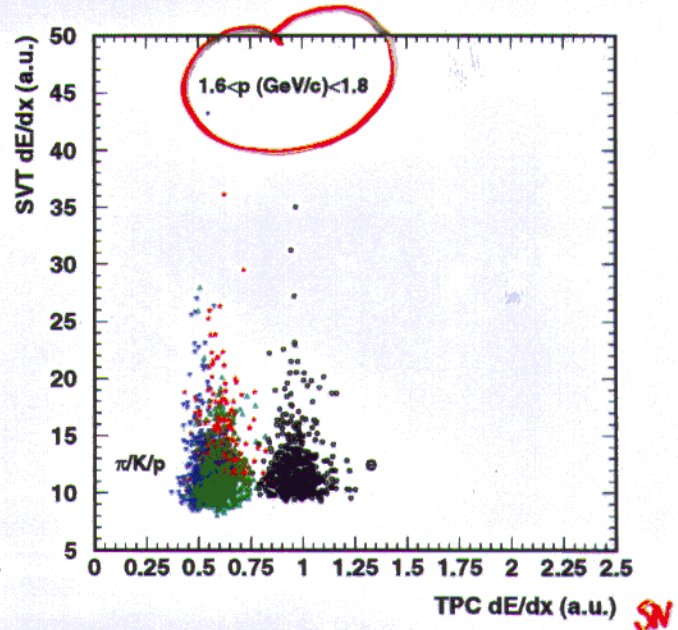
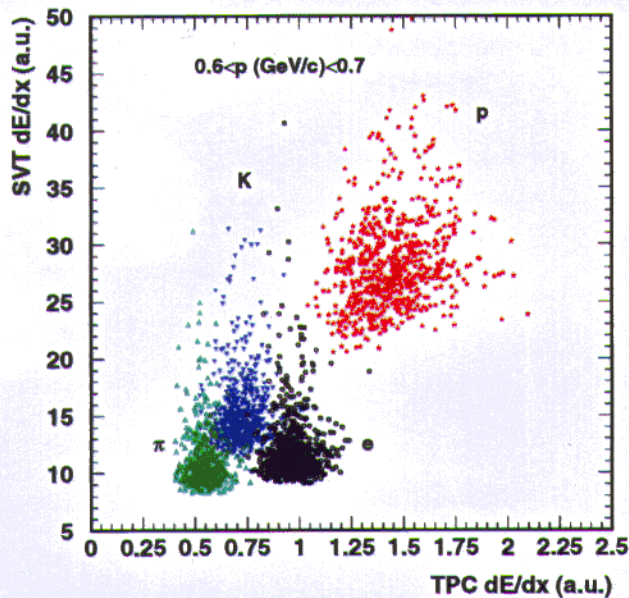

MOST DIFFICULT REGION FOR e/h separation
IS BELOW CALORIMETER THRESHOLD

$$1 < p \text{ (GeV/c)} < 2$$

TPC + SVT are powerful !!!

ACCESS TO LOW P_T J/ψ

- Triggering
- Rate

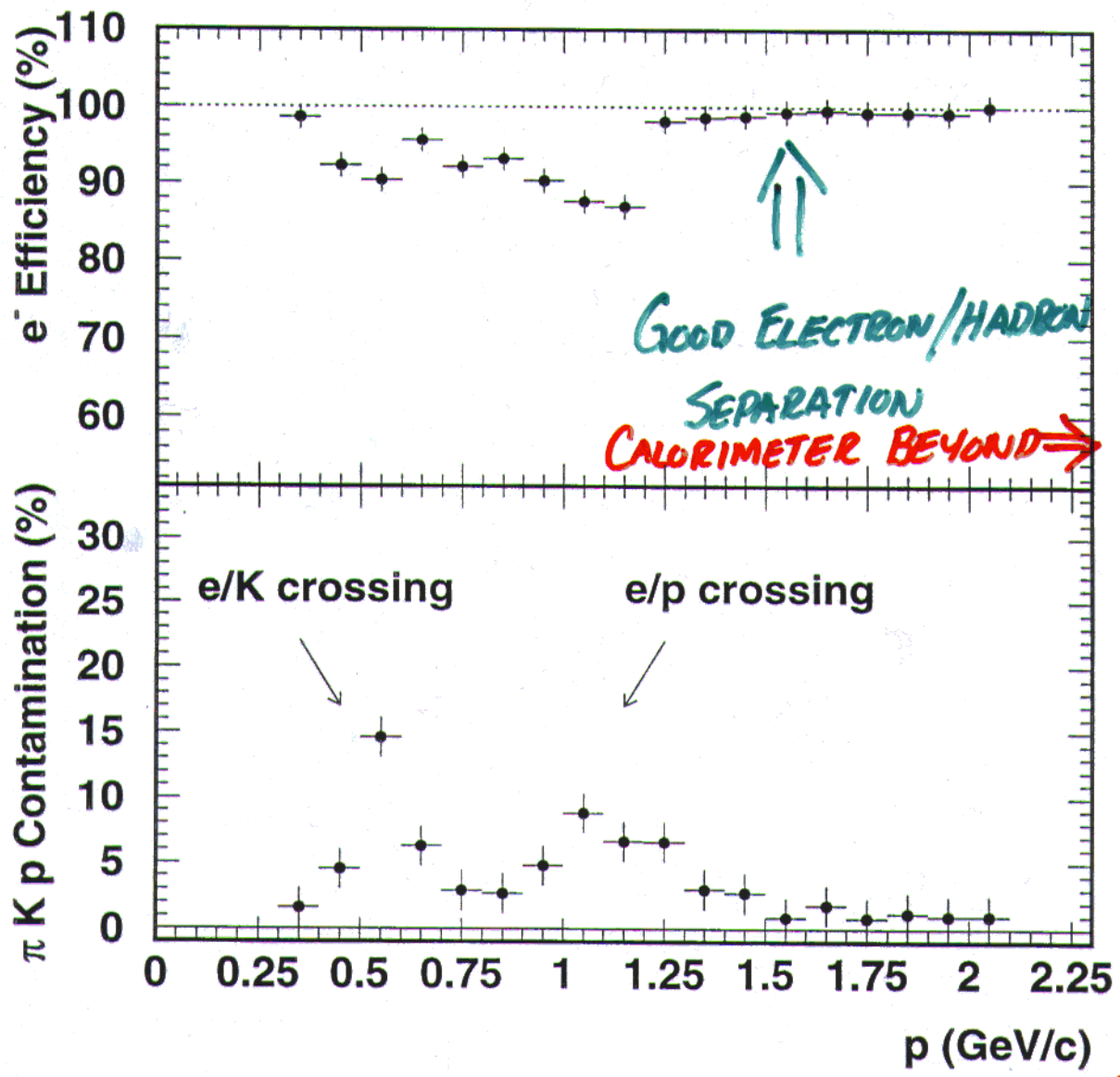

SN

- PID via dE/dx usable up to 2.5 GeV/c
- hadron rejection factor $\gtrsim 10$

J/ Ψ

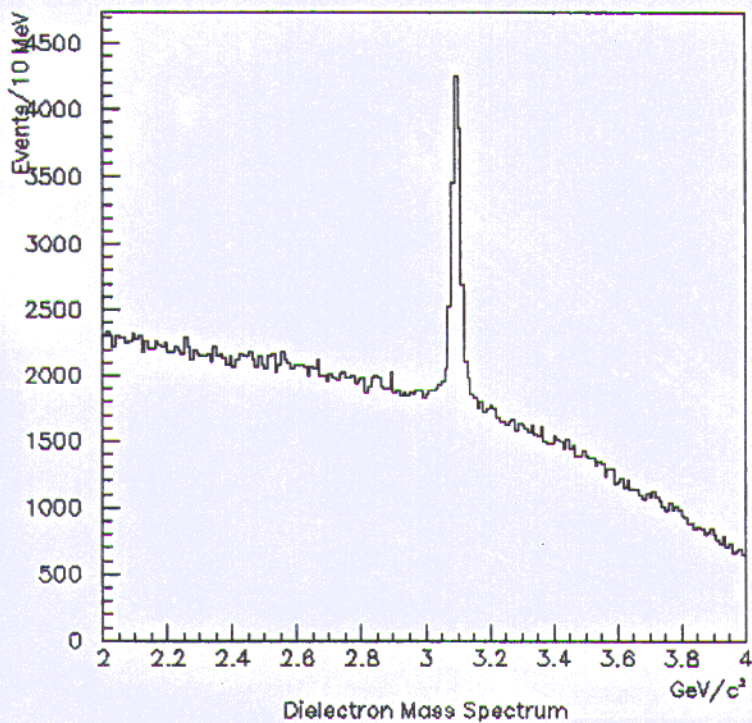

T. Lelancq SN

Work In Progress

- TPC reconstruction
- PID: - calorimeter
- ionisation